



Keyboard/Mouse/Monitor
Sharing Switch



User's Manual

SV431D
SV831D
SV1631D

StarTech.com



REGISTERED
ISO 9001

Table of Contents

Introduction

Overview	1
Features	2
Configurations	3

Installation

Device Connection	5
Initial Power-Up	7
Optional Rack Mount Accessories	8

Operation

Front Panel Push Buttons	9
OSD (On-Screen-Display) Operation	10
Hot Key Commands	15

Cascade Configuration

Connection	17
Change Configuration while Running	19

Appendices

Specifications	20
Trouble Shooting	21

Please read this manual thoroughly and follow the **Installation** procedures to prevent damage to the StarView or any connecting devices.

Introduction

Overview

One-Console StarView Switches

The StarView allows you to access multiple computers from **one** keyboard, mouse and monitor. There is no interface card or software to configure. Installation is as easy as connecting cables between the StarView and your computers. Operation is as simple as pressing push button, entering hot-key command and navigating through the user-friendly on-screen menu (available on models with OSD support). Depending on the model you have, it switches up to 4 (SV431D), 8 (SV831D) or 16 (SV1631D) IBM-compatible computers. The StarView is independent of the computer operating system.

On-Screen Display (OSD) Menu

For SV431D, SV831D, SV1631D

For StarViews with built-in OSD control, you can name your computers, switch to a computer from a list, configure settings with easy-to-use menus, and view the name of the selected computer on-screen with programmable time interval. The OSD displays the system status throughout operation.

Automatic Mouse Conversion

The StarView Switch enable you to connect computers with PS/2 or serial mouse ports (using adapters supplied with each StarView Switch) and control the computers from one PS/2 mouse. The StarView automatically identifies the mouse and switches to proper mouse protocol.

High Video Quality

StarView supports VGA resolution up to 1600x1200 @85Hz without any degradation. Advanced VGA circuit design guarantees smooth and flicker-free switching from one computer to the other with distance up to 100ft (30M)* at both Console and PC sides.

NOTE: This User's Manual is written for the following models.

StarView Switch Models			
No. of console supported	1	1	1
No. of PC supported	4	8	16
OSD	SV431D	SV831D	SV1631D

- Tested with high-quality UL2919-rated, low-loss and shielded cables.

Features

- Supports both PS/2 and serial mouse
- Cascade configuration expands system capability
- Auto-scan automatically selects computers sequentially
- Supports Microsoft IntelliMouse (Pro)
- Hot-key functions allow easy computer access
- Keyboard states automatically saved and restored when switching computers
- Operating system independent, transparent to all applications
- Plug and play system configuration
- Keyboard and mouse can be hot plugged at any time
- High VGA resolution 1600x1200
- DDC2B compatible
- Optional standard 19 inch rack mounting kit available
- Supports optional multimedia module for microphones and stereo speakers

Extra features for On-Screen Display model

- Assign computers with unique and meaningful names
- Identify and select computers by the names
- Programmable scan filters unused computers
- Store system settings and name entries to non-volatile memory
- Password security locks computer from unauthorized access
- Gain complete control with easy-to-use OSD interface

Configurations

StarView has several models each supporting a different number of computers. For applications with a large number of computers, StarViews can be cascaded in a master/slave configuration to support even more computers.

Single StarView Configuration

Connect a PS/2 keyboard, a PS/2 mouse and a VGA multi-sync monitor directly to the *Master's* **CONSOLE** port. Then, connect multiple sets of keyboard, mouse and monitor cables to the “**PC x**” ports of the StarView, as shown in figure 1.

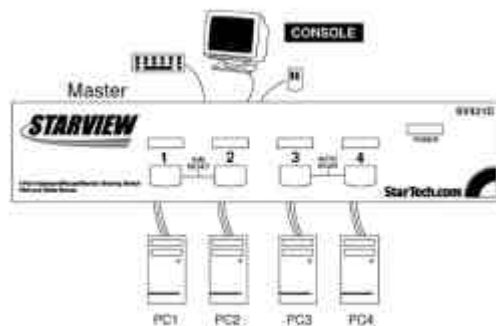

Figure 1: A single StarView configuration

Cascade (Master/Slave) Configuration

You can connect a second level of one or more StarViews to “**PC 1**”~“**PC 4**” (SV431D) or “**PC 1**”~“**PC 8**” ports (SV831D & SV1631D) of a *Master* unit. Cascade configuration expands system ability allowing you to select computers connected to the *Master* or *Slaves*. There is only one *Master*, which has a mouse, a keyboard and a monitor connected to its **CONSOLE** port directly operated by a user.

Once connected, StarViews automatically configure themselves to either *Master* or *Slave*. *Slaves* of different StarView models can be mixed in cascade configuration. [NOTE: *Master* must have equal or more PC ports than that of *Slaves*, i.e., if SV831D is a master, SV831D and SV431D can be *Slaves*, but SV1631D can not.]

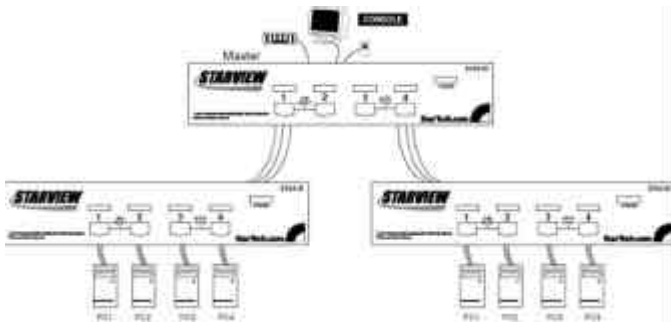

Figure 2: A cascade StarView configuration

Throughout this manual, *Master* is the StarView that has a physical keyboard, mouse and monitor connected to its **CONSOLE** port. *Slave* is a StarView that has its **CONSOLE** port connected to a *Master's* "PC x" port. *Slave* only exists in cascade configuration.

Installation

Device Connection

The monitor connected to the HD-DB-15 VGA port of a *Master CONSOLE* must be capable of synchronizing with the computer's video signal. If you are uncertain about the monitor type, please consult the monitor user's manual. Connect a PS/2 mouse and a keyboard to the **CONSOLE** port marked with a mouse and a keyboard respectively as shown in figure 3. [NOTE: Only a PS/2 mouse can be connected to the **CONSOLE** mouse port. The *StarView's* automatic mouse conversion system allows you to connect computers using serial mouse and control the computers from one PS/2 mouse.]

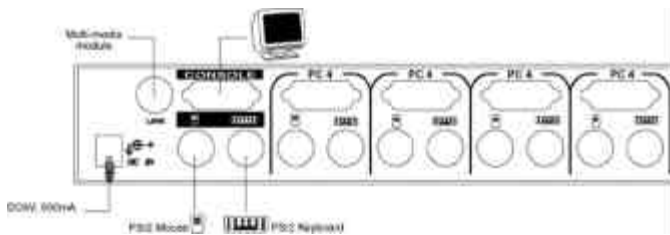

Figure 3: Master console connection

Determine the channel address of each computer. For computers using PS/2 mouse, connect the computer's mouse and keyboard cables to the StarView's connectors marked with a mouse and keyboard respectively, as shown in figure 4.

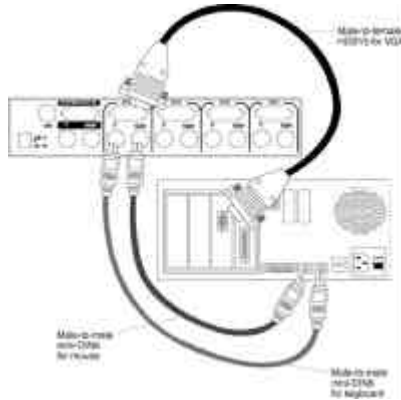

Figure 4: Master computer connection

For computers using serial mouse, connect the DB-9 to mini-DIN-6 adapter (supplied with the StarView) to the computer mouse port, then use PS/2 cables to connect the mouse to StarView, see figure 5. Connect the computer's monitor cable to the HD-DB-15 VGA connector. Repeat above steps for all remaining computers to be connected to the StarView.

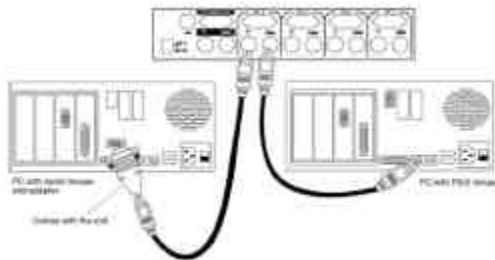

Figure 5: Adapter and serial mouse connection

Initial Power-Up

Make sure all computers and StarViews are powered down during installation. You must power up the Master StarView before turning on any other devices.

- ▶ *For single StarView:* 1) Apply a power adapter to the *Master*.
2) Turn on computers.
- ▶ *For cascade:* 1) Apply a power adapter to the *Master*.
2) Apply power adapters to all *Slaves*. 3) Turn on computers.

Note: You may hot plug additional powered-down computer and *Slave* without turning any existing StarView or computer off after initial power up.

Replace Master Console Devices

You can replace a faulty keyboard or mouse of the *Master* **CONSOLE** port at any time without powering down the Master, as long as your computers are booted with proper device driver for the new device. Should you encounter any difficulty, just activate **K/M RESET** by holding both front-panel '1' and '2' push buttons down for 2 seconds.

Adhesive Rubber Foot

For desktop operation, you may stick the four round rubber feet (supplied with the unit) to the bottom of the StarView. NOTE: Do not use the rubber feet for rack mount operation.

Optional Rack Mount Accessories

Figure 6 shows how to attach optional mounting brackets to the StarView unit for standard 19-inch rack cabinet.



Figure 6: Attaching rack mount bracket

Figure 7 shows how to assemble rack cable support then screw it to the back and inside the rack cabinet vertical post.

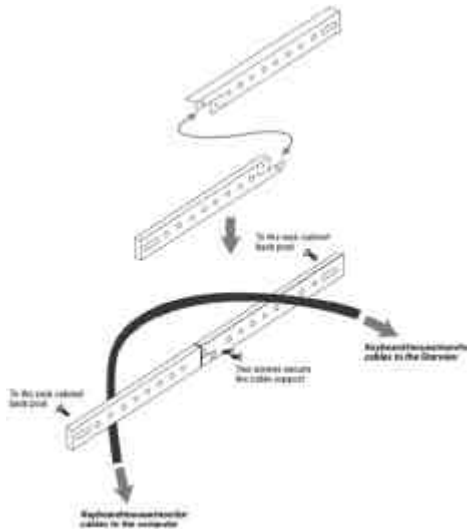

Figure 7: Assembling rack cable support

Then, keyboard/mouse/monitor cables can be routed over the cable support. You can use plastic cable ties to bundle and label the cables through the rack cable support holes for easy identification.

Operation

Front Panel Push Buttons

You may select a computer by pressing the front panel push button directly, by issuing hot-key commands or by activating the OSD window (for models with OSD support). The front panel indicator changes to reflect the computer port selected (red) and whether the port is connected to a powered computer (green). The indicator flashes red when it is in either *Auto Scan* or *Manual Scan* mode.

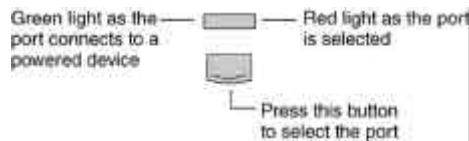

Figure 8: Front panel indicator

Some computers support 'keyboard/mouse power up' function, i.e., press certain keys or mouse buttons to startup the computers. Their corresponding green front indicators lit all the time even if the computers are 'off'.

■ K/M RESET

K/M RESET solves most problems developed by keyboard, mouse, device replacement or change of configuration. Press down both the front-panel number **1** and **2** push buttons for 2 seconds to re-configure the whole system without turning either the StarView Switch or any computer off.

■ AUTO SCAN

StarView provides an easy to use feature to start *Auto Scanning*. You can press down both the front-panel number **7** and **8** buttons for 2 seconds to start Auto Scanning.

OSD (On-Screen-Display) Operation

SV431D, SV831D, SV1631D

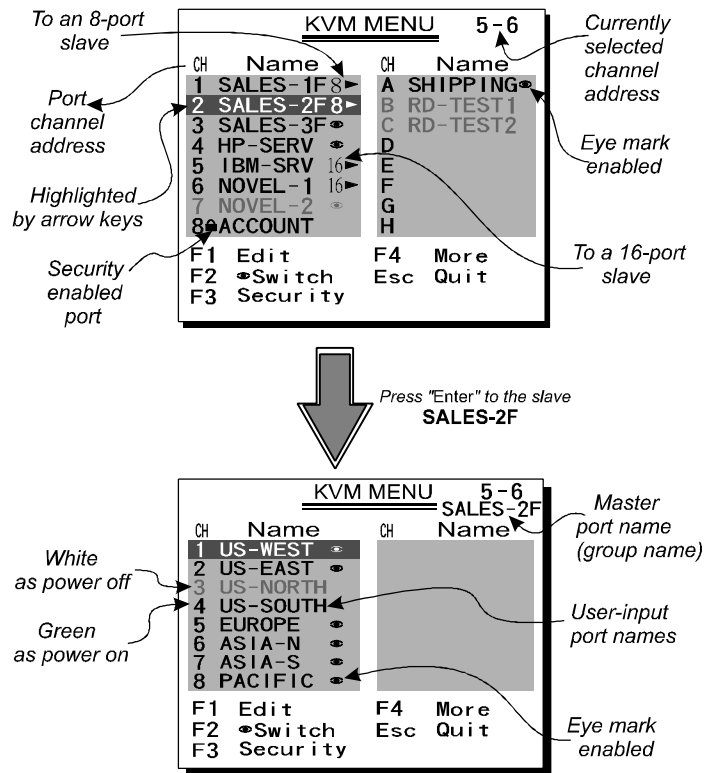

Figure 9: OSD screen illustration

By hitting the left <CTRL> key twice within two seconds, you may see the 'Hotkey Menu' if it is enabled (an OSD option). Or, by hitting the left <CTRL> key three times within two seconds, you will see a 'KVM MENU' screen showing a list of the computers with corresponding channel addresses, names and status, see figure 9. The channel address of the currently selected computer is displayed

in red, same as the front indicator, to the right of the OSD title 'KVM MENU'. The color of a device name is green if it has power and is ready for selection (its corresponding front panel indicator is green), or the color is white as it has no power. OSD menu updates the color when it is activated. Use the <UP> and <DOWN> arrow keys to highlight a computer and the <ENTER> key to select it. Or, you may press <ESCAPE> to exit OSD and remove the OSD menu from the display; the status window returns to the display and indicates the currently selected computer or operating status.

A triangle mark (▶) to the right of a name indicates the port is cascaded to a *Slave*; the number at the left of the triangle mark shows the number of ports the *Slave* has, i.e. 8 ▶ for SV831D. <ENTER> key brings you one level down and another screen pops up listing the names of the computers on that *Slave*. The name of the *Slave* will be shown at the upper right corner of the OSD menu. It is useful to group computers and still be able to see the group name.

An eye mark (👁) to the right of a name indicating the computer is selected to be monitored in Scan mode. In OSD, this mark can be switched on or off by function key <F2>.

Press <ESCAPE> key to exit OSD and to return to the selected computer; the computer name is also shown on the screen.

● **Function key <F1>**: To edit name entry of a computer or a *Slave*. First, use the <UP> and <DOWN> arrow keys to highlight a channel then press <F1> followed by name entry. Valid characters are 'A'~'Z', '0'~'9' and the dash character. Lowercase letters are converted to uppercase ones. Press <BACKSPACE> to delete a letter one at a time. Non-volatile memory stores all name entries until you change, even if the unit is powered down.

● **Function key <F2>**: To switch the eye mark (👁) of a computer on or off. First, use the <UP> and <DOWN> arrow keys to highlight it, then press <F2> to switch its eye mark on or off. If *Scan Type* is 'Ready PC + 👁', only the power-on and eye mark selected computers will be displayed sequentially in Scan mode.

● **Function key <F3>**: To lock a device (a computer or a *Slave*) from unauthorized access, use *Security*. *Security* is effective for only one device (a computer or a *Slave*). To lock a device, use the <UP> and <DOWN> arrow keys to highlight it, then press <F3>. Now, enter up to 4 characters ('A'~'Z', '0'~'9, '-') followed by <ENTER> as new password. A Security-enabled device is marked with a lock (🔒) following its channel number. To permanently disable the *security* function from a locked device, highlight it, press <F3> then enter the password.

If you want to access the locked device temporarily, simply highlight it and press <ENTER>, the OSD will ask you for the password. After entering correct password, you are allowed to use the device. This device is automatically re-locked once you switch to another one. During Scan mode, OSD skips the security-enabled device. NOTE: Only one device (a computer or a *Slave*) can be locked by this function at a time.

If you forget the password, the only way to permanently disable the security function is to remove all possible power sources from the master StarView. You need to turn off all computers and unplug all power adapters, then restart everything.

● **Function key <F4>**: More functions are available by hitting <F4>. A new screen pops up displaying more functions as described below. Most of them are marked with a triangle (▶) indicating there are options to choose from. Using the <UP> and <DOWN> arrow keys, select the functions and press <ENTER>.

Available options will be shown in the middle of the screen. Again, using the <UP> and <DOWN> arrow keys to view options then press <ENTER> to select it. You can press <ESCAPE> to exit at any time.

■ **Auto Scan**

In this mode, the StarView automatically switches from one power-on computer to the next sequentially in a fixed interval. During *Auto Scan* mode, the OSD displays the name of the selected computer.

When *Auto Scan* detects any keyboard or mouse activity, it suspends the scanning till activity stops; it then resumes with the next computer in sequence. To abort the *Auto Scan* mode, press the left <CTRL> twice, or, press any front button. *Scan Type* and *Scan Rate* set the scan pattern. *Scan Type* (<F4>: More\Scan Type) determines if scanned computers must also be eye mark selected. *Scan Rate* (<F4>: More\Scan Rate) sets the display interval when a computer is selected before selecting the next one.

■ *Manual Scan*

Scan through power-on computers one by one by keyboard control. *Scan Type* (<F4>: More\Scan Type) determines if scanned computers must also be eye mark selected. Press the up arrow key (↑) to select the previous computer and the down arrow key (↓) to select the next computer. Press any other key to abort the *Manual Scan* mode.

■ *Audio Stick*

An optional multimedia module can be LINKed to the back of each StarView for selecting microphone and stereo speaker signals. There are two options for *Audio Stick*: **ON** and **Off**. When set to '**On**', audio selection follows computer selection. When set to '**Off**', audio selection stops following computer selection. It is useful if you want to listen to a particular computer's audio signal while operating other computers. The non-volatile memory stores the *Audio Stick* setting.

■ *Scan Type*

Ready PC +: In Scan mode, scan through power-on and eye mark selected computers.

Ready PC: In Scan mode, scan through power-on computers. The non-volatile memory stores the *Scan Type* setting.

■ *Scan Rate*

Sets the duration of a computer displayed in *Auto Scan* mode. The options are **3 seconds, 8 seconds, 15 seconds and 30 seconds**. The non-volatile memory stores the *Scan Rate* setting.

■ *Keyboard Speed*

StarView offers keyboard typematic setting that overrides the similar settings in BIOS and in Windows. Available speed options are **Low**, **Middle**, **Fast** and **Faster** as 10, 15, 20 and 30 characters/sec respectively. The non-volatile memory stores the Keyboard Speed setting.

■ *Hotkey Menu*

When you hit the left <CTRL> key twice within two seconds, the "Hotkey Menu" appears displaying a list of hot-key commands if the option is **On**. The 'Hotkey Menu' can be turned **Off** if you prefer not to see it when the left <CTRL> key is hit twice.

The non-volatile memory stores the Hotkey Menu setting.

■ *CH Display*

Auto Off: After you select a computer, the channel address and name of the computer will appear on the screen for 3 seconds then disappear automatically.

Always On: The channel address and name of a selected computer and/or OSD status displayed on the screen all the time.

The non-volatile memory stores the CH Display setting.

■ *Position*

The position of the selected computer name and/or OSD status displayed on screen during operation. The actual display position shifts due to different VGA resolution, the higher the resolution the higher the display position. The non-volatile memory stores the Position setting.

UL as Upper Left, **UR** as Upper Right,

LL as Lower Left, **LR** as Lower Right.

MI as Middle,

- **ESC:** To exit the OSD, press the <ESCAPE> key

Hot-key commands

Hot-key command is a short keyboard sequence to select a computer, to activate computer scan, etc. StarView interprets keystrokes for hot-keys all the time. A hot-key sequence starts with two left <CTRL> keystrokes followed by one or two more keystrokes. A built-in buzzer generates a high-pitch beep for correct hot-key command; otherwise, one low-pitch beep for error and the bad key sequence will not be forwarded to the selected computer.

The short form hot-key menu can be turned on as an OSD function (<F4>: More\Hotkey Menu) every time the left <CTRL> key is pressed twice.

L-CTRL: is the <CTRL> key located at the left side of the keyboard.

1~8/A~H: are the number keys '1' ~ '8' at the upper row of the keyboard and character keys 'A' ~ 'H' case insensitive. *Do not use the keypad at the right of the keyboard.*

■ To select a computer by hot-key command, you must know its channel address, which is determined by the StarView connection. For a computer connected to a *Master*, its address is represented by the PC port label (1~8 or A~H). For a computer connected to a *Slave*, two characters represent its address. The first character is the channel address of the *Master* unit (1~8) and the second one is the channel address of the *Slave* (1~8 or A~H). Please note that only *Master's* 'PC 1' ~ 'PC 8' ports can be connected to a *Slave*.

Left **Ctrl** + left **Ctrl** + **7**

Selects a computer connected to port 7 of the *Master*.

Left **Ctrl** + left **Ctrl** + **6** + **C**

Selects a computer connected to port C of a *Slave* connected to port 6 of the *Master*.

■ To start *Auto Scan*, automatically scan power-on computers one by one at a fixed interval:

left **Ctrl** + left **Ctrl** + **F 1**

When *Auto Scan* detects any keyboard or mouse activity, it suspends the scanning till activity stops; it then resumes with the next computer in sequence. The length of the *Auto Scan* interval (*Scan Rate*) is adjustable, see below.

To abort the *Auto Scan* mode, press the left **Ctrl** key twice.

Note: For OSD models, *Scan Type* determines whether eye mark is necessary during *Auto Scan*.

■ *Manual Scan* enables you to manually switch back and forth between power-on computers.

left **Ctrl** + left **Ctrl** + **F2**

Press **↑** or **↓** to select the previous or the next computer in sequence. And, press any other key to abort the *Manual Scan*.

Note: For OSD models, *Scan Type* determines whether eye mark is necessary during *Manual Scan*.

■ To adjust *Scan Rate* which sets the duration before switching to the next computer in *Auto Scan*:

left **Ctrl** + left **Ctrl** + **F3**

The StarView sends one to four beeps indicating scan interval of **3**, **8**, **15** and **30** seconds respectively.

■ To adjust keyboard typematic rate (characters/sec), this setting over-rides that of BIOS and any operating system:

left **Ctrl** + left **Ctrl** + **F4**

The StarView generates 1 to 4 beeps corresponding to **10**, **15**, **20** and **30** characters/sec respectively.

■ *Audio Stick*

An optional multimedia module can be LINKed to the back of each StarView for selecting microphone and stereo speaker signals.

There are two options for *Audio Stick*: **ON** and **Off**. When set to '**On**', audio selection follows computer selection. When set to '**Off**', audio selection stops following computer selection. It is useful if you want to listen to a particular computer's audio signal while operating other computers.

left **Ctrl** + left **Ctrl** + **F5**

The StarView generates 1 or 2 beeps corresponding to **On** and **Off** respectively.

Cascade Configuration

Connection

Before connecting a device (a computer or a Slave) to the Master under power, you must turn off the device. The Master must have equal or more 'PC x' ports than that of the Slave, i.e., if SV831D is the master, SV831D and SV431D can be Slaves, but SV1631D can not.

The ports labeled "PC 1"~"PC 8" can be connected to either a computer or a Slave's **CONSOLE** port, as shown in figure 10.

The ports "PC A"~"PC H" can only be connected to a computer.

A power adapter with DC 9V/500mA output rating must be connected to the Master.

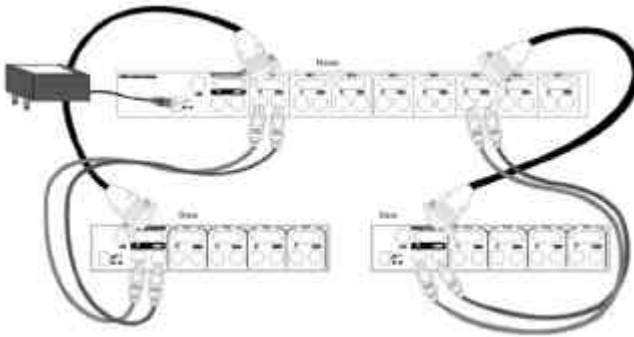

Figure 10: Slave console connection

The maximum number of computers controlled by a master/slave configuration with all SV431Ds is 16 with 4 Slaves and each Slave connects to 4 computers, see figure 11. For an all SV831Ds configuration, the number is 64 with 8 Slaves and each Slave connects to 8 computers, see figure 12. For an all SV1631D configuration, the number is 136, see figure 13. The Master SV1631D connects to 8 Slaves and 8 computers, and each Slave connects to 16 computers.

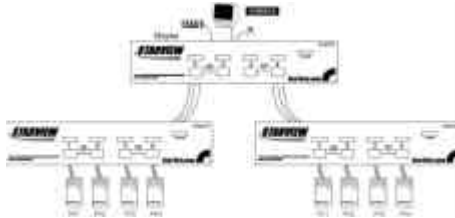

Figure 11: Cascaded 4-port StarViews

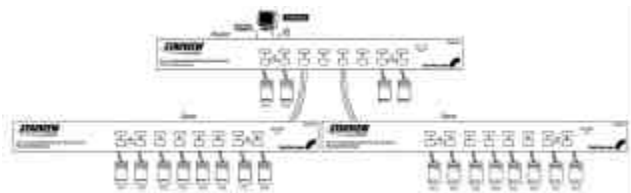

Figure 12: Cascaded 8-port StarViews

For OSD model:

After connection completes, you should re-activate the OSD menu to check if the *Master* recognizes the *Slaves*. A triangle mark (▶) is placed to the right of the channel name indicating the port is connected to a *Slave not* a computer. A number to the left of the triangle mark indicates the *Slave* model, i.e. 8 ▶ for SV831D or SV831DD.

Change Configuration while Running

Devices at any 'PC x' port can be changed at any time after initial power-up. If you change any one of the "PC 1" to "PC 8" ports connection from a computer to a *Slave* or vice versa, or replace the devices of a port; the OSD will update this change the next time it is activated. [NOTE: Any new device, a computer or a *Slave*, must be turned off before it is connected to the *Master*.

Appendices

Specifications:

Specifications	SV431D	SV831D	SV1631D
User port number	1	1	1
Computer port number	4	8	16
Cascade control PC number	Up to 16*	Up to 64*	Up to 136*
On-screen display (OSD)	Yes		
Front panel button control	4	8	16
Hot plug-and-play	Yes		
Hot-key control	Yes		
Rack-mount kit	Not Shipped With unit	Shipped With Unit	Shipped With Unit
Automatic scan interval	3, 8, 15, 30 seconds		
Programmable scan pattern	Yes		
Cable length (Max)	30M (100ft) at CONSOLE 30M (100ft) at PC ports		
VGA	1600 x 1200, DDC2B		
keyboard	PS/2		
Computer mouse connector	PS/2, serial (with adapter)		
monitor	HD-DB-15 male		
keyboard	PS/2		
Console mouse connector	PS/2		
monitor	HD-DB-15 female		
H x W x D (mm)	44x220x13	44x436x18	88x436x22
(in.)	0	0	0
size	1.7x8.7x5.1	1.7x17.2x7.	3.5x17.2x8
	Compact	0	.7
		1U	2U
Power supply (min)	9V DC, 500mA		

- Cascaded with StarView Switches supporting the same number of PC ports. You can mix different models in cascade applications.

Troubleshooting:

Ensure that all cables are well seated. Check that keyboard/mouse cables are not swapped. Label and bundle the cables for each computer to avoid confusion when connected to the StarView.

Symptom Possible causes Recommended solutions

No OSD screen	No power to StarView Loose monitor connection Monitor not multi-sync	Establish power by turning on computers, wait, press left CTRL keys several times. Reconnect monitor Use multi-sync monitor
Keyboard error on boot	Loose keyboard connection	Make sure keyboard cables are Well seated
Master/slave does not work	Improper installation procedures	Make sure slave's CONSOLE is connected to <i>Master's</i> PC 1~ PC 8 port Press and hold the 1 and 2 push buttons to initiate K/M reset Remove any possible power supply to the slave (unplug all cables), before connecting it to the <i>Master</i>
Keyboard strokes shifted	The computer was in shifted state when last switched	Press both SHIFT keys
The and keys do not work in <i>Manual Scan</i>	All PCs are off or only one PC is turned on. Scan mode works for power-on computers only <i>Scan type</i> is eye mark selected but no PC is eye mark selected in OSD.	Turn computers on. Press any other key to abort <i>Manual Scan</i> mode. Set proper <i>Scan type</i> in OSD and determine which PCs are eye mark selected, do it in OSD.
<i>Auto Scan</i> does not switch PC and StarView beeps from time to time and red indicator flashes	All PCs are off or only one PC is turned on. Scan mode works for power-on computers only <i>Scan type</i> is eye mark selected but no power-up PC is eye mark selected in OSD.	Turn on computers Set proper <i>Scan Type</i> in OSD and determine which PCs are eye mark selected, do it in OSD. Press left CTRL key twice to abort <i>Auto Scan</i> mode. Press any front button to select a PC, and <i>Auto Scan</i> stops.

Double OSD images at cascade configuration	Improper slave connection procedure.	Press push buttons 1 and 2 down for 2 seconds to activate K/M RESET. Remove any possible power supply to the <i>Slave</i> (unplug all cables), before connecting it to the <i>Master</i> .
OSD menu is not at the proper position	OSD menu has fixed resolution and its size varies due to computer VGA resolution changes.	Use <F4>: More\Position to select UL or UR. OSD menu may appear near the middle of the screen when LL or LR is selected.
Computer can not use serial mouse	Loose mouse adapter Incorrect mouse adapter	Secure the mouse adapter to computer's COM port Use only the mouse adapter comes with the unit
Can not select a computer connected to a slave	Improper <i>Master</i> unit connection Improper slave unit connection Too many levels of slaves	Only <i>Master</i> ports PC1~PC8 can be connected to slaves. Connect slave CONSOLE port to PC1~PC8 ports of the <i>Master</i> Only one level of slave units is allowed. Pop up OSD again to check if <i>Master</i> recognizes the slave connection. Look for triangle mark and the number before it.
The StarView fails to function occasionally.	Computers do not supply enough power.	Make sure a power adapter with minimum of 9V 500mA-output rating is firmly connected to the power jack.

Limited Warranty

IN NO EVENT SHALL THE DIRECT VENDOR'S LIABILITY FOR DIRECT OR INDIRECT, SPECIAL, INCIDENTAL OR CONSEQUENTIAL DAMAGES, LOSS OF PROFIT, LOSS OF BUSINESS, OR FINANCIAL LOSS WHICH MAY BE CAUSED BY THE USE OF THE PRODUCT EXCEEDS THE PRICE PAID FOR THE PRODUCT.

The direct vendor makes no warranty or representation, expressed or implied with respect to the contents or use of this documentation, and especially disclaims its quality, performance, merchantability, or fitness for any particular purpose.

The direct vendor also reserves the right to revise or update the product or documentation without obligation to notify any user of such revisions or updates. For further information, please contact your direct vendor.

All the brand names and registered trademarks are the property of their respective owners.